

# 6146W/7212

## Beam Power Tube

90 WATTS CW INPUT  
(ICAS) UP TO 60 Mc

60 WATTS CW INPUT  
(ICAS) AT 175 Mc

For Use as an RF Power Amplifier and Oscillator  
as well as an AF Power Amplifier and Modulator  
Under Severe Shock and Vibration Conditions

### GENERAL DATA

#### Electrical:

Heater, for Unipotential Cathode:		
Voltage (AC or DC) . . . . .	6.3 ± 10%	volts
Current at heater volts = 6.3 . . . . .	1.25	amp
Transconductance, for plate volts =		
200, grid-No.2 volts = .200, and		
plate ma. = 100 . . . . .	7000	μmhos
Mu-Factor, Grid No.2 to Grid No.1		
for plate volts = 200, grid-No.2		
volts = 200, and plate ma. = 100. . . . .	4.5	
Direct Interelectrode Capacitances: <sup>a</sup>		
Grid No.1 to plate. . . . .	0.24 max.	pf
Grid No.1 to cathode & grid No.3		
& internal shield, grid No.2,		
base sleeve, and heater . . . . .	13.0	pf
Plate to cathode & grid No.3		
& internal shield, grid No.2,		
base sleeve, and heater . . . . .	8.5	pf

#### Mechanical:

Operating Position. . . . .	Any
Maximum Overall Length. . . . .	3-13/16"
Seated Length . . . . .	3-1/8" + 1/8"
Maximum Diameter. . . . .	1-21/32"
Weight (Approx.). . . . .	2 oz
Bulb. . . . .	T12
Cap . . . . .	Small (JEDEC No.C1-1)
Socket. . . . .	Standard Octal 8-Contact
Base. . . . .	Small Micanol-Wafer Octal 8-Pin with "770" Sleeve (JEDEC Group 1, No.B8-150)

<sup>a</sup>Basing Designation for BOTTOM VIEW. . . . . 7CK

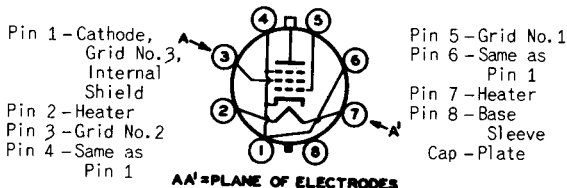

# 6146W/7212

## AF POWER AMPLIFIER & MODULATOR — Class AB<sub>1</sub><sup>b</sup>

### Maximum Ratings, Absolute-Maximum Values:

	CCS <sup>c</sup>	ICAS <sup>d</sup>	
DC PLATE VOLTAGE. . . . .	600 max.	750 max.	volts
DC GRID-NO.2 VOLTAGE. . . . .	250 max.	250 max.	volts
MAX.-SIGNAL DC PLATE CURRENT <sup>e</sup> . . . . .	125 max.	135 max.	ma
MAX.-SIGNAL PLATE INPUT <sup>e</sup> . . . . .	60 max.	85 max.	watts
MAX.-SIGNAL GRID-NO.2 INPUT <sup>e</sup> . . . . .	3 max.	3 max.	watts
PLATE DISSIPATION <sup>e</sup> . . . . .	20 max.	25 max.	watts
PEAK HEATER-CATHODE VOLTAGE:			
Heater negative with respect to cathode. . . . .	135 max.	135 max.	volts
Heater positive with respect to cathode. . . . .	135 max.	135 max.	volts
BULB TEMPERATURE (At hottest point on bulb surface). . . . .	220 max.	220 max.	°C

### Typical CCS Push-Pull Operation:

*Values are for 2 tubes*

DC Plate Voltage. . . . .	400	500	600	volts
DC Grid-No.2 Voltage <sup>f</sup> . . . . .	190	185	180	volts
DC Grid-No.1 Voltage:				
From fixed-bias source. . . . .	-40	-40	-45	volts
Peak AF Grid-No.1-to-Grid-No.1 Voltage <sup>g</sup> . . . . .				
	80	80	90	volts
Zero-Signal DC Plate Current. . . . .	63	57	26	ma
Max.-Signal DC Plate Current. . . . .	228	215	200	ma
Zero-Signal DC Grid-No.2 Current . . . . .				
	2.5	2	1	ma
Max.-Signal DC Grid-No.2 Current . . . . .				
	25	25	23	ma
Effective Load Resistance (Plate to plate). . . . .				
	4000	5500	7000	ohms
Max.-Signal Driving Power (Approx.) . . . . .				
	0	0	0	watts
Max.-Signal Power Output (Approx.) . . . . .				
	55	70	82	watts

### Typical ICAS Push-Pull Operation:

*Values are for 2 tubes*

DC Plate Voltage. . . . .	600	750	volts
DC Grid-No.2 Voltage <sup>f</sup> . . . . .	200	195	volts
DC Grid-No.1 Voltage:			
From fixed-bias source. . . . .	-50	-50	volts
Peak AF Grid-No.1-to-Grid-No.1 Voltage <sup>g</sup> . . . . .			
	100	100	volts
Zero-Signal DC Plate Current. . . . .	28	23	ma
Max.-Signal DC Plate Current. . . . .	229	220	ma
Zero-Signal DC Grid-No.2 Current. . . . .			
	1	1	ma
Max.-Signal DC Grid-No.2 Current. . . . .			
	27	26	ma
Effective Load Resistance (Plate to plate). . . . .			
	6000	8000	ohms
Max.-Signal Driving Power (Approx.) . . . . .			
	0	0	watts
Max.-Signal Power Output (Approx.) . . . . .			
	95	120	watts



# 6146W/7212

## Maximum Circuit Values (CCS or ICAS):

Grid-No.1-Circuit Resistance under any condition:<sup>h,j</sup>  
 With fixed bias . . . . . 0.1 max. megohm  
 With cathode bias . . . . . Not recommended

## AF POWER AMPLIFIER & MODULATOR — Class AB<sub>1</sub><sup>b</sup>

Triode Connection—Grid No.2 Connected to Plate

	CCS	ICAS	
<b>Maximum Ratings, Absolute-Maximum Values:</b>			
DC PLATE VOLTAGE. . . . .	400 max.	400 max.	volts
MAX.—SIGNAL DC PLATE CURRENT <sup>e</sup> . . . . .	90 max.	90 max.	ma
MAX.—SIGNAL PLATE INPUT <sup>e</sup> . . . . .	35 max.	35 max.	watts
PLATE DISSIPATION <sup>e</sup> . . . . .	20 max.	25 max.	watts
PEAK HEATER-CATHODE VOLTAGE:			
Heater negative with respect to cathode. . . . .	135 max.	135 max.	volts
Heater positive with respect to cathode. . . . .	135 max.	135 max.	volts
BULB TEMPERATURE (At hottest point on bulb surface). . . . .	220 max.	220 max.	°C

## Typical Push-Pull Operation:

Values are for 2 tubes

DC Plate Voltage. . . . .	250	400	400	volts
DC Grid-No.1 Voltage. . . . .	-50	-100	-100	volts
Peak AF Grid-No.1-to-Grid-No.1 Voltage <sup>g</sup> . . . . .	100	200	200	volts
Zero-Signal DC Plate Current. . . . .	120	40	40	ma
Max.—Signal DC Plate Current. . . . .	125	100	100	ma
Effective Load Resistance (Plate-to-plate). . . . .	5000	8000	8000	ohms
Max.—Signal Driving Power (Approx.) . . . . .	0	0	0	watts
Max.—Signal Power Output (Approx.) . . . . .	10	22	22	watts

## Maximum Circuit Values (CCS or ICAS):

Grid-No.1-Circuit Resistance under any condition:<sup>h,k</sup>  
 With fixed bias . . . . . 0.1 max. megohm  
 With cathode bias . . . . . 0.5 max. megohm

## AF POWER AMPLIFIER & MODULATOR — Class AB<sub>2</sub><sup>m</sup>

Maximum Ratings, Absolute-Maximum Values:

	CCS	ICAS	
DC PLATE VOLTAGE. . . . .	600 max.	750 max.	volts
DC GRID-No.2 VOLTAGE. . . . .	250 max.	250 max.	volts
MAX.—SIGNAL DC PLATE CURRENT <sup>e</sup> . . . . .	125 max.	135 max.	ma
MAX.—SIGNAL PLATE INPUT <sup>e</sup> . . . . .	62.5 max.	90 max.	watts
MAX.—SIGNAL GRID-No.2 INPUT <sup>e</sup> . . . . .	3 max.	3 max.	watts
PLATE DISSIPATION <sup>e</sup> . . . . .	20 max.	25 max.	watts



# 6416W/7212

	CCS	ICAS	
PEAK-HEATER-CATHODE VOLTAGE:			
Heater negative with respect to cathode. . . . .	135 max.	135 max.	volts
Heater positive with respect to cathode. . . . .	135 max.	135 max.	volts
BULB TEMPERATURE (AT hottest point on bulb surface). . . . .	220 max.	220 max.	°C

## Typical CCS Push-Pull Operation:

*Values are for 2 tubes*

DC Plate Voltage. . . . .	400	500	600	volts
DC Grid-No.2 Voltage <sup>f</sup> . . . . .	175	175	165	volts
DC Grid-No.1 Voltage:				
From fixed-bias source. . . . .	-41	-44	-44	volts
Peak AF Grid-No.1-to-Grid-No.1 Voltage . . . . .	95	102	97	volts
Zero-Signal DC Plate Current. . . . .	33	27	22	ma
Max.-Signal DC Plate Current. . . . .	232	242	207	ma
Zero-Signal DC Grid-No.2 Current . . . . .	1.1	0.7	0.6	ma
Max.-Signal DC Grid-No.2 Current . . . . .	18	18	17	ma
Max.-Signal DC Grid-No.1 Current . . . . .	1.6	1.9	1.1	ma
Effective Load Resistance (Plate to plate). . . . .	3700	4600	6800	ohms
Max.-Signal Driving Power (Approx.) <sup>n</sup> . . . . .	0.2	0.3	0.2	watt
Max.-Signal Power Output (Approx.) . . . . .	62	83	90	watts

## Typical ICAS Push-Pull Operation:

*Values are for 2 tubes*

DC Plate Voltage. . . . .	600	750	volts
DC Grid-No.2 Voltage <sup>f</sup> . . . . .	190	165	volts
DC Grid-No.1 Voltage:			
From fixed-bias source. . . . .	-48	-46	volts
Peak AF Grid-No.1-to-Grid-No.1 Voltage. . . . .	109	108	volts
Zero-Signal DC Plate Current. . . . .	28	22	ma
Max.-Signal DC Plate Current. . . . .	270	240	ma
Zero-Signal DC Grid-No.2 Current. . . . .	1.2	0.3	ma
Max.-Signal DC Grid-No.2 Current. . . . .	20	20	ma
Max.-Signal DC Grid-No.1 Current. . . . .	2	2.6	ma
Effective Load Resistance (Plate to plate). . . . .	5000	7400	ohms
Max.-Signal Driving Power (Approx.) <sup>n</sup> . . . . .	0.3	0.4	watt
Max.-Signal Power Output (Approx.) . . . . .	113	131	watts

## Maximum Circuit Values (CCS or ICAS):

Grid-No.1-Circuit Resistance: <sup>n</sup>			
With fixed bias . . . . .	30000 max.		ohms
With cathode bias . . . . .			Not recommended



## PLATE-MODULATED RF POWER AMPLIFIER — Class C Telephony

Carrier conditions per tube for use  
with a maximum modulation factor of 1

	CCS	ICAS	
<b>Maximum Ratings, Absolute-Maximum Values:</b>			
DC PLATE VOLTAGE. . . . .	480 max.	600 max.	volts
DC GRID-No.2 VOLTAGE. . . . .	250 max.	250 max.	volts
DC GRID-No.1 VOLTAGE. . . . .	-150 max.	-150 max.	volts
DC PLATE CURRENT. . . . .	117 max.	125 max.	ma
DC GRID-No.1 CURRENT. . . . .	3.5 max.	4 max.	ma
PLATE INPUT . . . . .	45 max.	67.5 max.	watts
GRID-No.2 INPUT . . . . .	2 max.	2 max.	watts
PLATE DISSIPATION . . . . .	13.3 max.	16.7 max.	watts
<b>PEAK HEATER-CATHODE VOLTAGE:</b>			
Heater negative with respect to cathode. . . . .	135 max.	135 max.	volts
Heater positive with respect to cathode. . . . .	135 max.	135 max.	volts
BULB TEMPERATURE (At hottest point on bulb surface). . . . .	220 max.	220 max.	°C

### Typical Operation:

At frequencies up to .60 Mc

DC Plate Voltage. . . . .	400	475.	600	volts
DC Grid-No.2 Voltage: <sup>P</sup>				
From a grid-No.2 series re- sistor of:				
33000 ohms. . . . .	150	-	-	volts
51000 ohms. . . . .	-	135	-	volts
56000 ohms. . . . .	-	-	150	volts
DC Grid-No.1 Voltage: <sup>Q</sup>				
From a grid-No.1 resistor of				
27000 ohms. . . . .	-87	-77	-87	volts
Peak RF Grid-No.1 Voltage . . .	107	95	107	volts
DC Plate Current. . . . .	112	94	112	ma
DC Grid-No.2 Current. . . . .	7.8	6.4	7.8	ma
DC Grid-No.1 Current (Approx.).	3.4	2.8	3.4	ma
Driving Power (Approx.) . . . . .	0.4	0.3	0.4	watt
Power Output (Approx.) . . . . .	32	34	52	watts

### Maximum Circuit Values (CCS or ICAS):

Grid-No.1-Circuit Resistance <sup>R</sup> . . . . .	30000 max.	ohms
---	------------	------

## RF POWER AMPLIFIER & OSCILLATOR — Class C Telegraphy<sup>S</sup> and

## RF POWER AMPLIFIER — Class C FM Telephony

	CCS	ICAS	
<b>Maximum Ratings, Absolute-Maximum Values:</b>			
DC PLATE VOLTAGE. . . . .	600 max.	750 max.	volts
DC GRID-No.2 VOLTAGE. . . . .	250 max.	250 max.	volts
DC GRID-No.1 VOLTAGE. . . . .	-150 max.	-150 max.	volts
DC PLATE CURRENT. . . . .	140 max.	150 max.	ma
DC GRID-No.1 CURRENT. . . . .	3.5 max.	4 max.	ma



# 6146W/7212

	CCS	ICAS	
PLATE INPUT . . . . .	67.5 max.	90 max.	watts
GRID-No.2 INPUT . . . . .	3 max.	3 max.	watts
PLATE DISSIPATION . . . . .	20 max.	25 max.	watts
PEAK HEATER-CATHODE VOLTAGE:			
Heater negative with respect to cathode. . . . .	135 max.	135 max.	volts
Heater positive with respect to cathode. . . . .	135 max.	135 max.	volts
BULB TEMPERATURE (At hottest point on bulb surface). . . . .	220 max.	220 max.	°C

## Typical Operation:

*As amplifier up to 60 Mc*

DC Plate Voltage. . . . .	500	600	600	750	volts
DC Grid-No.2 Voltage: <sup>t</sup> . . . . .					
From a grid-No.2 series resistor of:					
36000 ohms. . . . .	170	-	-	-	volts
51000 ohms. . . . .	-	150	-	-	volts
43000 ohms. . . . .	-	-	180	-	volts
56000 ohms. . . . .	-	-	-	160	volts
DC Grid-No.1 Voltage: <sup>u</sup>					
From a grid-No.1 resistor of:					
27000 ohms. . . . .	-66	-	-	-	volts
20000 ohms. . . . .	-	-58	-	-62	volts
24000 ohms. . . . .	-	-	-71	-	volts
From a cathode resistor of:					
430 ohms. . . . .	-	-	-71	-	volts
470 ohms. . . . .	-66	-58	-	-62	volts
Peak RF Grid-No.1 Voltage . . . . .	84	73	91	79	volts
DC Plate Current. . . . .	135	112	150	120	ma
DC Grid-No.2 Current. . . . .	9	9	10	11	ma
DC Grid-No.1 Current (Approx.). . . . .	2.5	2.8	2.8	3.1	ma
Driving Power (Approx.) . . . . .	0.2	0.2	0.3	0.2	watt
Power Output (Approx.) . . . . .	48	52	66	70	watts

## Typical Operation:

*As amplifier up to 175 Mc*

DC Plate Voltage. . . . .	320		400		volts
DC Grid-No.2 Voltage: <sup>t</sup> . . . . .					
From grid-No.2 series resistor of:					
13000 ohms. . . . .	180		-		volts
20000 ohms. . . . .	-		190		volts
DC Grid-No.1 Voltage: <sup>u</sup>					
From a grid-No.1 resistor of:					
27000 ohms. . . . .	-51		-		volts
24000 ohms. . . . .	-		-54		volts
From a cathode resistor of:					
330 ohms. . . . .	-51		-54		volts
Peak RF Grid-No.1 Voltage . . . . .	64		68		volts
DC Plate Current. . . . .	140		150		ma
DC Grid-No.2 Current. . . . .	10		10.4		ma
DC Grid-No.1 Current (Approx.). . . . .	2		2.2		ma



Driving Power (Approx.) . . . . .	3	3	watts
Power Output (Approx.). . . . .	25	35	watts

## Maximum Circuit Values (CCS or ICAS):

Grid-No.1 Circuit Resistance<sup>r</sup> . . . . . 30000 max. ohms

- a Without external shield.
- b Subscript 1 indicates that grid-No.1 current does not flow during any part of the input cycle.
- c Continuous Commercial Service.
- d Intermittent Commercial and Amateur Service.
- e Averaged over any audio-frequency cycle of sine-wave form.
- f Obtained preferably from a separate source or from the plate-voltage supply with a voltage divider.
- g The driver stage should be capable of supplying the No.1 grids of the class AB<sub>1</sub> stage with the specified driving voltage at low distortion.
- h The type of input coupling network used should not introduce too much resistance in the grid-No.1 circuit. Transformer or impedance coupling devices are recommended.
- j When the 6146W/7212 is operated as a beam power tube in Class AB<sub>1</sub> service, only fixed bias should be used, and the dc grid-No.1-circuit resistance should never exceed the specified value of 0.1 megohm.
- k When the 6146W/7212 is connected as a triode and its grid No.1 is operated with the fixed bias, the dc grid-No.1-circuit resistance should never exceed the specified value of 0.1 megohm. If higher values of grid-No.1-circuit resistance are desired, cathode bias must be employed. Under no circumstances should the dc grid-No.1-circuit resistance exceed the specified value of 0.5 megohm.
- m Subscript 2 indicates that grid-No.2 current flows during some part of the input cycle.
- n Driver stage should be capable of supplying the specified driving power at low distortion to the No.1 grids of the AB<sub>2</sub> stage. To minimize distortion, the effective resistance per grid-No.1 circuit of the AB<sub>2</sub> stage should be held at a low value. For this purpose, the use of transformer coupling is recommended. In no case, however, should the total dc grid-No.1-circuit resistance exceed 30000 ohms when the 6146W/7212 is operated at maximum ratings. For operation at less than maximum ratings, the dc grid-No.1-circuit resistance may be as high as 100000 ohms.
- p Obtained preferably from a separate source modulated along with the plate supply, or from the modulated plate supply through a series resistor.
- q Obtained from grid-No.1 resistor or from a combination of grid-No.1 resistor with either fixed supply or cathode resistor.
- r When grid No.1 is driven positive and the 6146W/7212 is operated at maximum ratings, the total dc grid-No.1-circuit resistance should not exceed the specified value of 30000 ohms. If this value is insufficient to provide adequate bias, the additional required bias must be supplied by a cathode resistor or a fixed supply. For operation at less than maximum ratings, the dc grid-No.1-circuit resistance may be as high as 100000 ohms.
- s Key-down conditions per tube without amplitude modulation. Amplitude modulation essentially negative may be used if the positive peak of the audio-frequency envelope does not exceed 115 per cent of the carrier conditions.
- t Obtained preferably from separate source, or from the plate-supply voltage with a voltage divider, or through a series resistor. A series grid-No.2 resistor should be used only when the 6146W/7212 is used in a circuit which is not keyed. Grid-No.2 voltage must not exceed 400 volts under key-up conditions.
- u Obtained from fixed supply, by grid-No.1 resistor, by cathode resistor, or by combination methods.



# 6146W/7212

## CHARACTERISTICS RANGE VALUES

	Note	Min.	Max.	
Heater Current . . . . .	1	1.175	1.325	amp
Direct Interelectrode Capacitances:				
Grid No.1 to plate . . . . .	2	-	0.24	pf
Grid No.1 to cathode & grid No.3 & internal shield, grid No.2, base sleeve and heater . . . . .	2	12.0	15.0	pf
Plate to cathode & grid No.3 & internal shield, grid No.2, base sleeve, and heater . . . . .	2	7.3	9.5	pf
Plate Current . . . . .	3	46	94	ma
Grid-No.2 Current . . . . .	3	-	5.5	ma
Heater-Cathode Leakage Current:				
Heater 100 volts negative with respect to cathode . .	1	-	100	μa
Heater 100 volts positive with respect to cathode . .	1	-	100	μa
Useful Power Output . . . . .	4	47	-	watts
Mu-Factor, Grid No.1 to Grid No.2 . . . . .	5	3.6	5.4	

Note 1: With 6.3 volts ac on heater.

Note 2: Without external shield.

Note 3: With 6.3 volts ac on heater, dc plate volts = 300, dc grid-No.2 volts = 200, and dc grid-No.1 volts = -33.

Note 4: In a single-tube, self-excited oscillator circuit, and with 6.3 volts ac on heater, dc plate volts = 600, dc grid-No.2 volts = 180, grid-No.1 resistor (ohms) = 30,000 ± 10%, dc plate ma. = 100 to 112, dc grid-No.2 ma. = 23 maximum, dc grid-No.1 ma. = 2 to 2.5 and frequency (Mc) = 15.

Note 5: With 6.3 volts ac on heater, dc plate volts = 200, plate ma. = 100, and grid-No.2 volts = 200.

## SPECIAL RATINGS & PERFORMANCE DATA

### 500-g Shock Rating:

This test is performed on a sample lot of tubes from each production run. Tubes are held rigid and are subjected in four different positions to an impact acceleration of 500 g. At the end of this test, tubes are required to meet the following limits:

Useful RF Power Output . . . . . 42 min. watts

For conditions shown under *Characteristics Range Values*, Note 4.

Heater-Cathode

Leakage Current . . . . . See *Characteristics Range Values*

The tubes must also meet the established limit for low-frequency vibration (See below).

### Fatigue Rating:

This test is performed on a sample lot of tubes from each production run. Tubes are rigidly mounted and subjected to 2.5-g vibrational acceleration at 25 cycles per second for 32





hours in each of three positions. At the end of this test, tubes are required to meet the following limits:

Useful RF Power Output . . . . . 42 min. watts

For conditions shown under *Characteristics Range Values*,  
*Note 4*.

Heater-Cathode

Leakage Current . . . . . See *Characteristics Range Values*

The tubes must also meet the established limit for low-frequency vibration (See below).

## Low-Frequency Vibration Performance:

This test is performed on a sample lot of tubes from each production run under the following conditions: Heater volts = 6.3, plate-supply volts = 250, grid-No.2 volts = 200, grid-No.1 voltage varied to give a plate current of 10 milliamperes, plate load resistor (ohms) = 2000, and vibrating frequency of 25 cycles per second with a fixed amplitude of 0.040 inch (total excursion 0.080 inch). The rms output voltage across the plate load resistor as a result of vibration of the tube must not exceed 500 millivolts.

## Variable-Frequency Vibration Performance (1):

This test is performed on a sample lot of tubes from each production run. Tubes are vibrated in each of 3 positions through frequency range of from 10 to 50 cycles per second, and back to 10 cycles per second. The tubes are vibrated under the same conditions as specified for *Low-Frequency Vibration Performance*. During the test, the tubes will not show an rms output voltage across the plate load resistor in excess of 500 millivolts. At the end of this test, the tubes will not show tap or permanent interelectrode shorts or defects that cause the tubes to be inoperable.

## Variable-Frequency Vibration Performance (2):

This test is performed on a sample lot of tubes from each production run. Tubes are vibrated in each of 3 positions, perpendicular and parallel to major axis of the tube, and parallel to longitudinal axis of the tube, through the frequency range from 50 to 120 cycles per second at a fixed acceleration of 10 g under the same voltage, current and load conditions as specified for *Low-Frequency Vibration Performance*. During this test, the tubes will not show an rms output voltage across the plate load resistor in excess of 500 millivolts.



# 6146W/7212

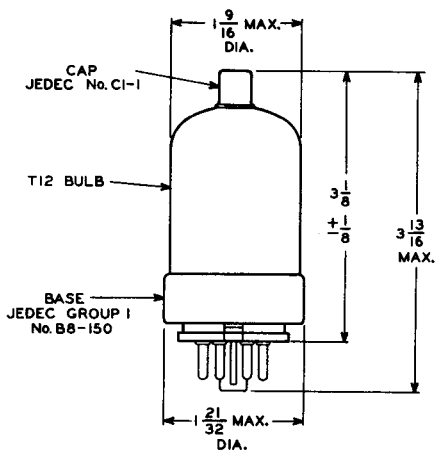

92CS-9625R4

ALL DIMENSIONS IN INCHES

## RATING CHART I Class C Telephony Service

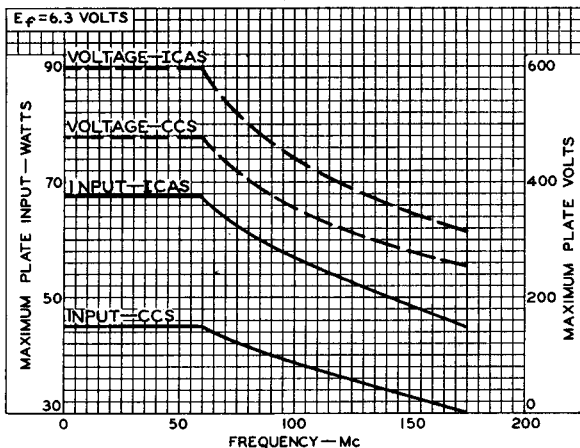

92CS-9614

## RATING CHART II Class C Telegraphy Service

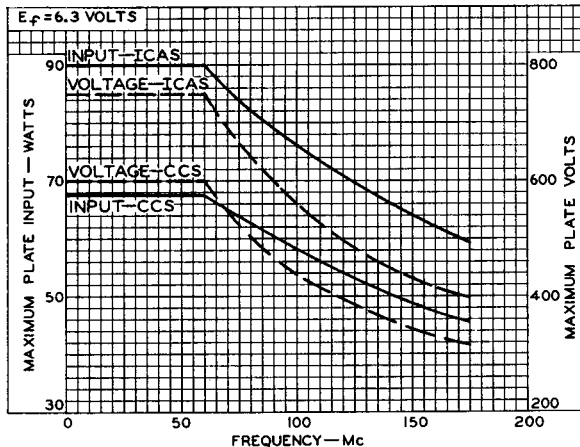

92CS-9615



## TYPICAL PLATE CHARACTERISTICS

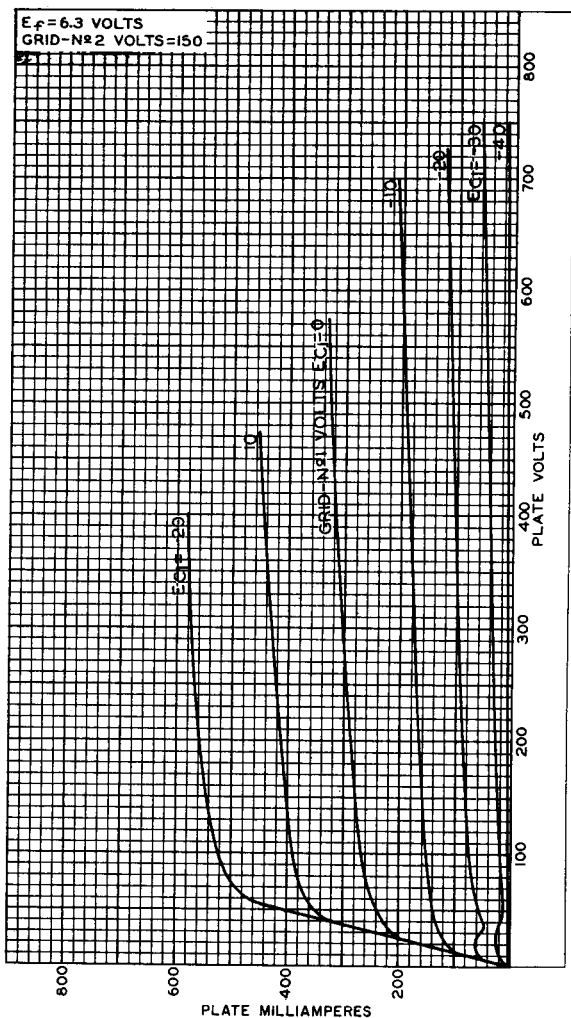

92CM-8145



## TYPICAL CHARACTERISTICS

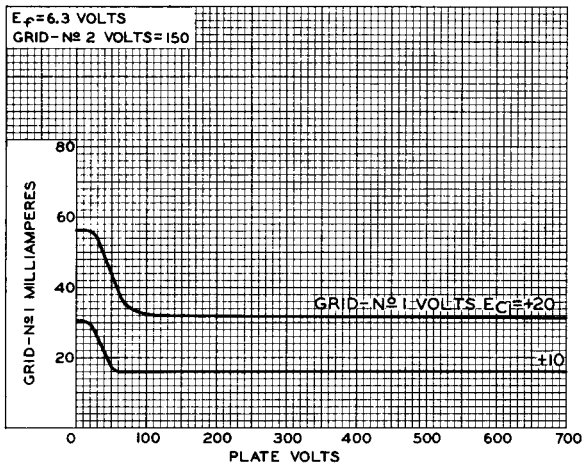

92CS-9619

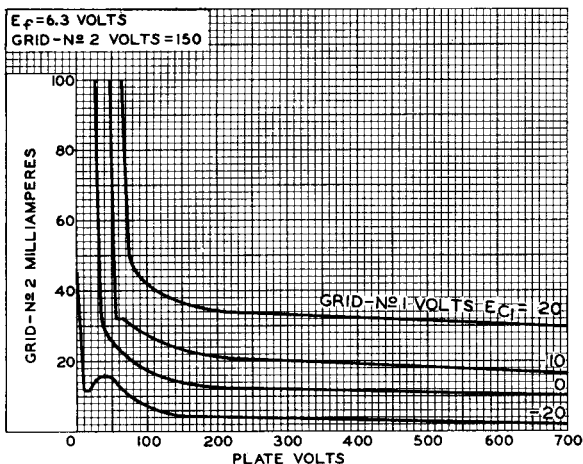

92CS-9620



# 6146W/7212

## TYPICAL PLATE CHARACTERISTICS

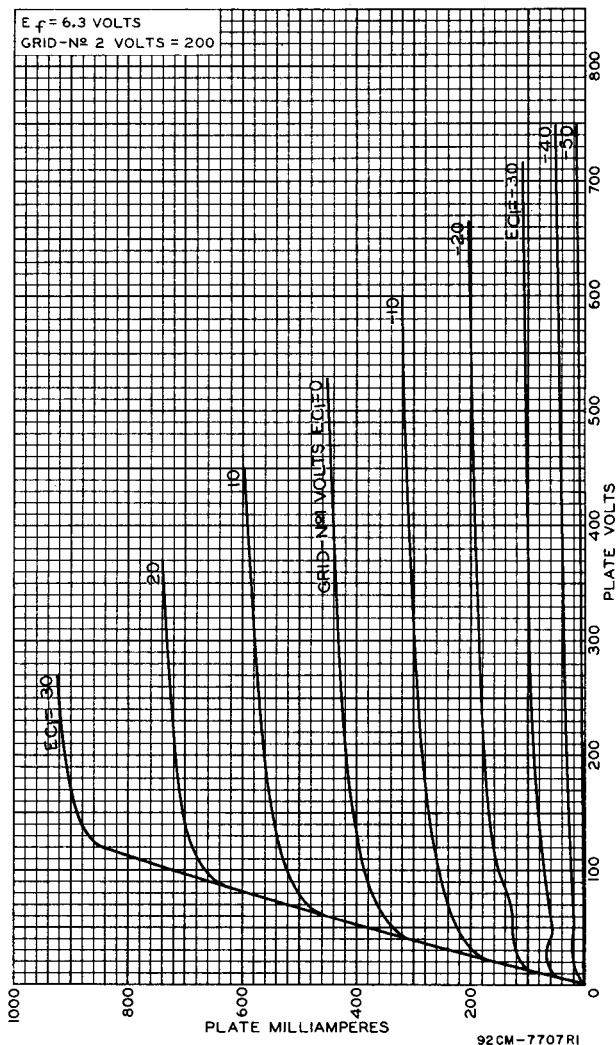

RADIO CORPORATION OF AMERICA  
Electron Tube Division

Harrison, N. J.



## TYPICAL CHARACTERISTICS

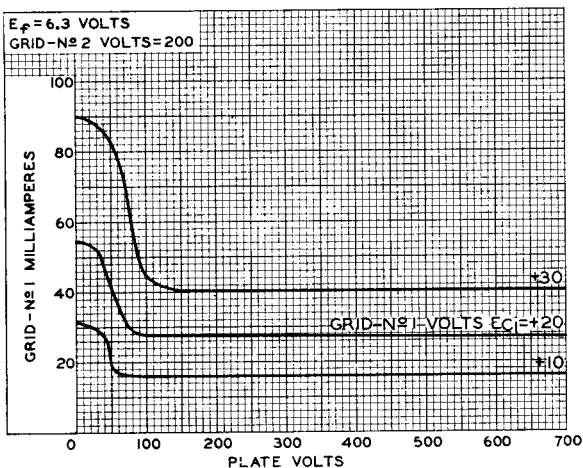

92CS-9617

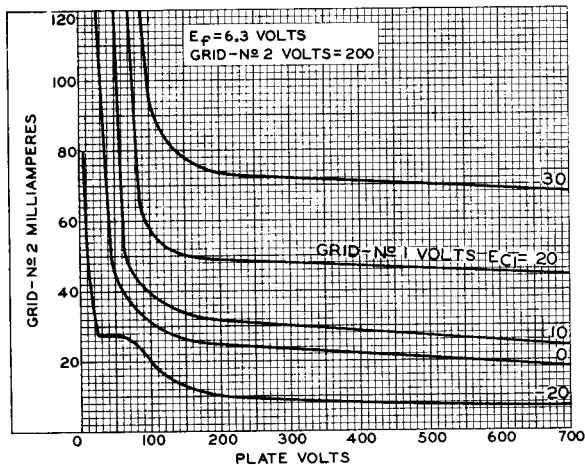

92CS-9618



